

# CV048C

	Date	Name	 <small>THE INFORMATION CONTAINED IN THIS DRAWING IS THE SOLE PROPERTY OF CAVANOVA. ANY REPRODUCTION IN PART OR AS A WHOLE WITHOUT THE WRITTEN PERMISSION OF CAVANOVA IS PROHIBITED.</small>	
Design:	03/12/2018	Diego		
Checked:		Diego		
Modified:		Diego		
Notes:	Scale: 1:10	Part name: CV048C	Top assembly: CV048C	
		Description: Vinoteca para 48botellas		
		Client:		
		Material:		
			Reference: CV048C	
			Count:	
			Pages: 1 OF 4	

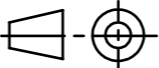

ALZADO

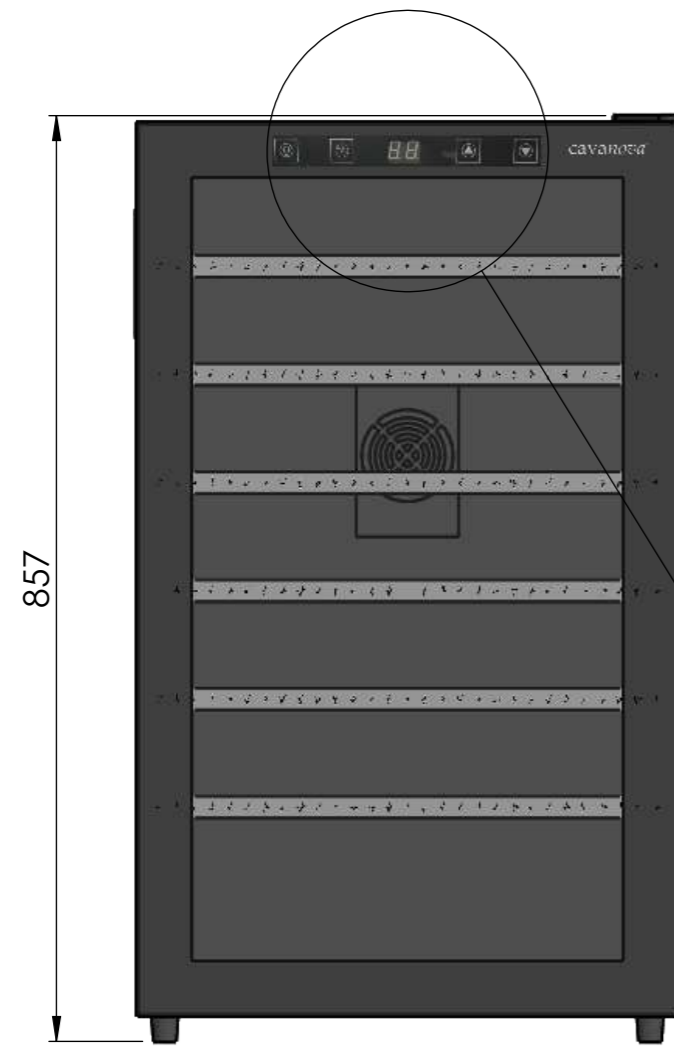

PERFIL

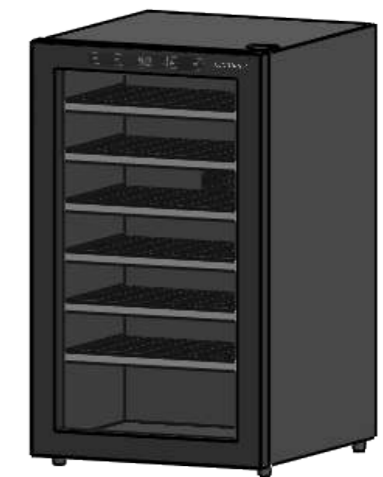

PLANTA

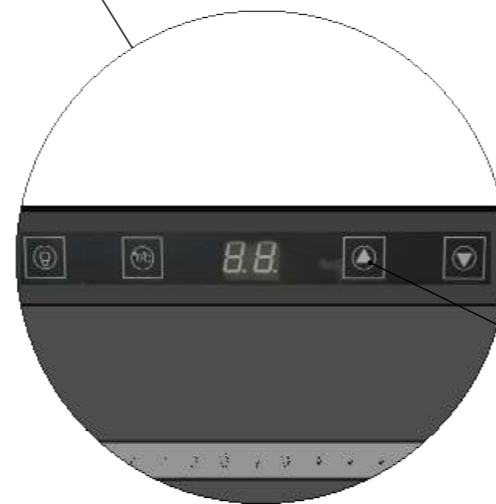

control táctil  
temperatura  
y luz

DATOS TÉCNICOS	
Volumen	140L
Botellas	48
Frecuencia	50-60hz
Consumo	0.63(15°C)kw/d
Voltaje	220/240V
Ruido	43db
Humedad interior	>70% RH
Refrigerante	R600a
Sistema de frío	Compresor
Rango de temperatura	5-20°C

	Date	Name
Design:	03/12/2018	Diego
Checked:		Diego
Modified:		Diego
Scale: 1:10	Part name:	Top assembly:
Unit:	CV048C	CV048C

**cavanova**  
THE INFORMATION CONTAINED IN THIS DRAWING IS THE SOLE PROPERTY OF CAVANOVA WINE S.L. IN MÁLAGA, SPAIN. ANY REPRODUCTION IN PART OR AS A WHOLE WITHOUT THE WRITTEN PERMISSION OF CAVANOVA WINE S.L. IS PROHIBITED.

Sign:

Description:  
**Vinoteca para 48botellas**

Client:  
 Material:  
 Reference: CV048C  
 Count:  
 Pages: 2 OF 4

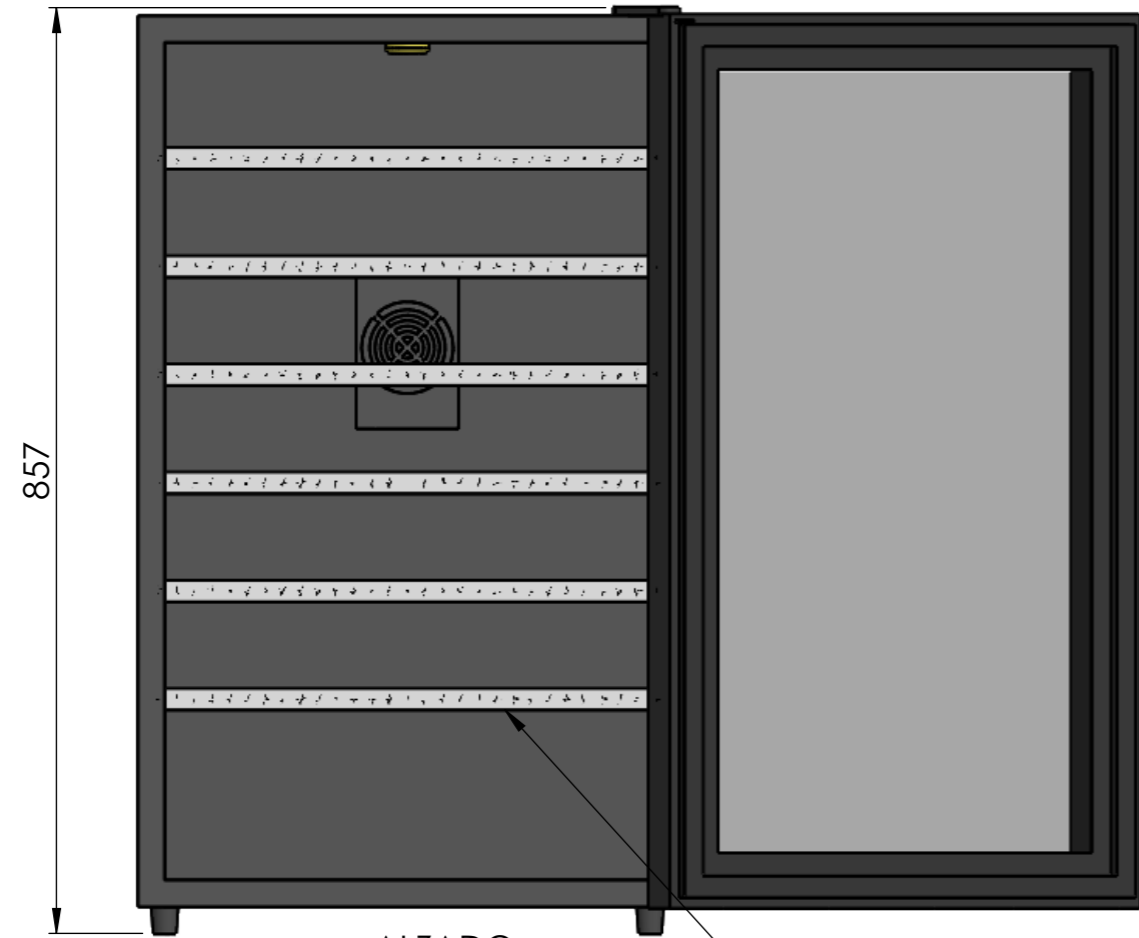

857

ALZADO

6 baldas de metal con acabado en inoxidable

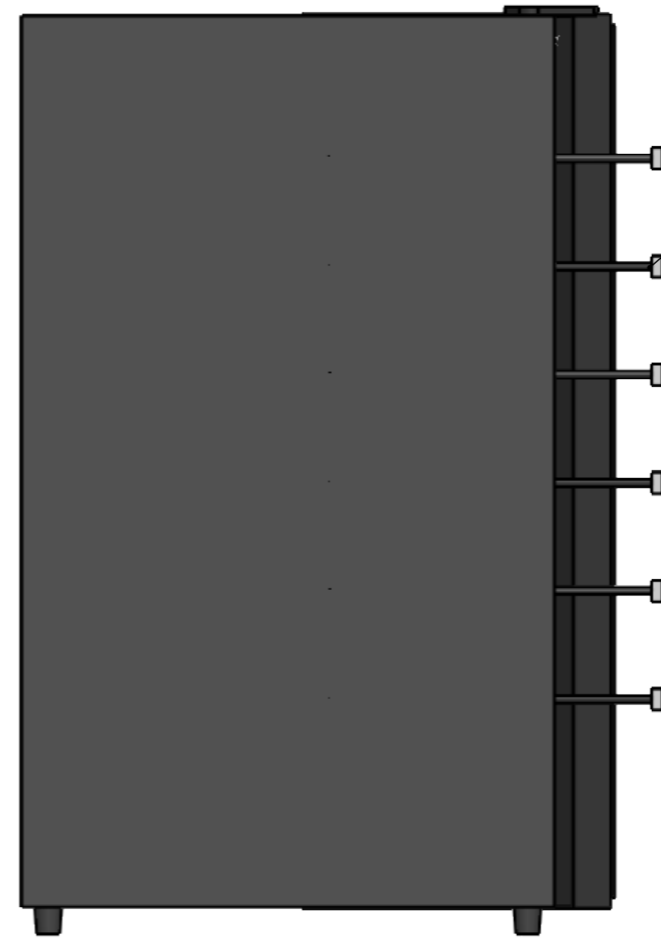

PERFIL

Baldas extraibles

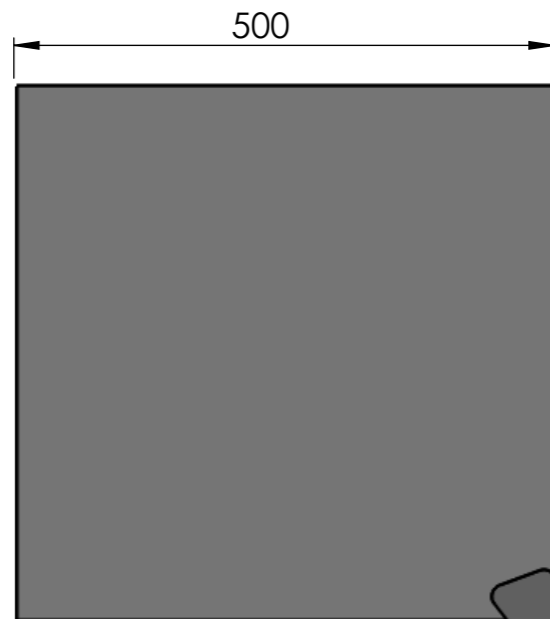
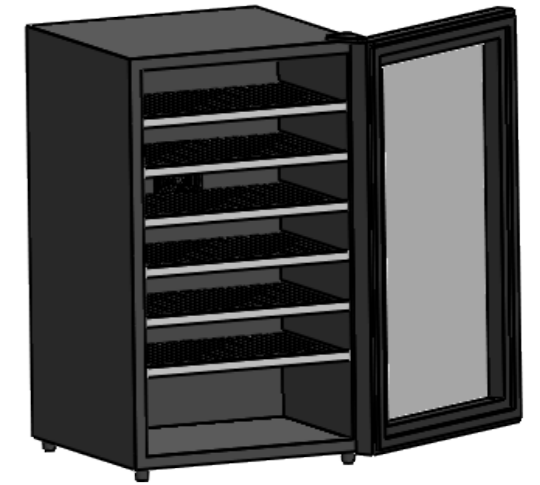

500

PLANTA

DATOS TÉCNICOS	
Volumen	140L
Botellas	48
Frecuencia	50-60hz
Consumo	0.63(15°C)kw/d
Voltaje	220/240V
Ruido	43db
Humedad interior	>70% RH
Refrigerante	R600a
Sistema de frío	Compresor
Rango de temperatura	5-20°C

	Date	Name
Design:	03/12/2018	Diego
Checked:		Diego
Modified:		Diego

**cavanoa**

THE INFORMATION CONTAINED IN THIS DRAWING IS THE SOLE PROPERTY OF CAVANOVA WINE S.L. IN MÁLAGA, SPAIN. ANY REPRODUCTION IN PART OR AS A WHOLE WITHOUT THE WRITTEN PERMISSION OF CAVANOVA WINE S.L. IS PROHIBITED.

Sign:

Scale: 1:10  
Unit:

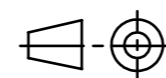

Part name:  
CV048C

Description:  
Vinoteca para 48botellas

Top assembly:  
CV048C

Client:  
Material:  
Reference: CV048C  
Count:  
Pages: 3 OF 4

MEDIDAS RECOMENDADAS	
ALTURA	907mm mín
PROFUNDIDAD	100mm mín(libre atrás)
ANCHURA	50mm por cada lado

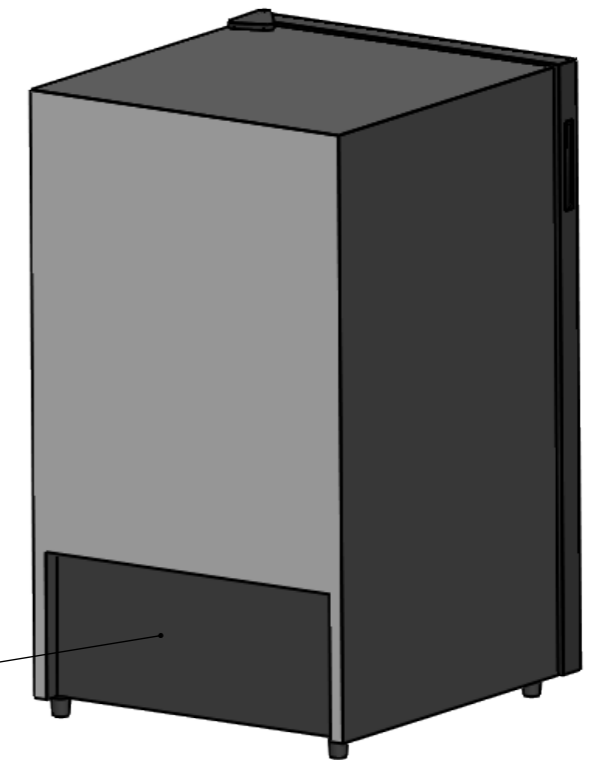
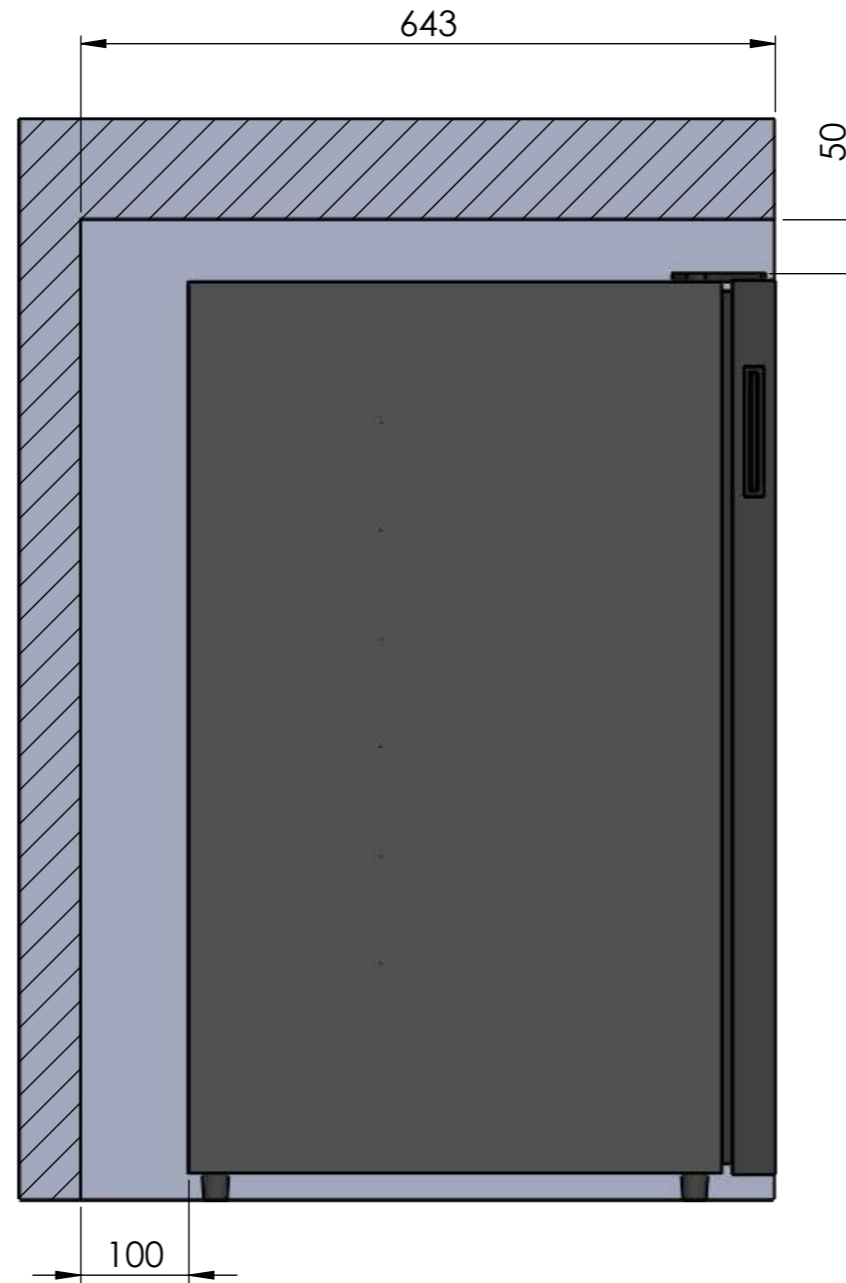
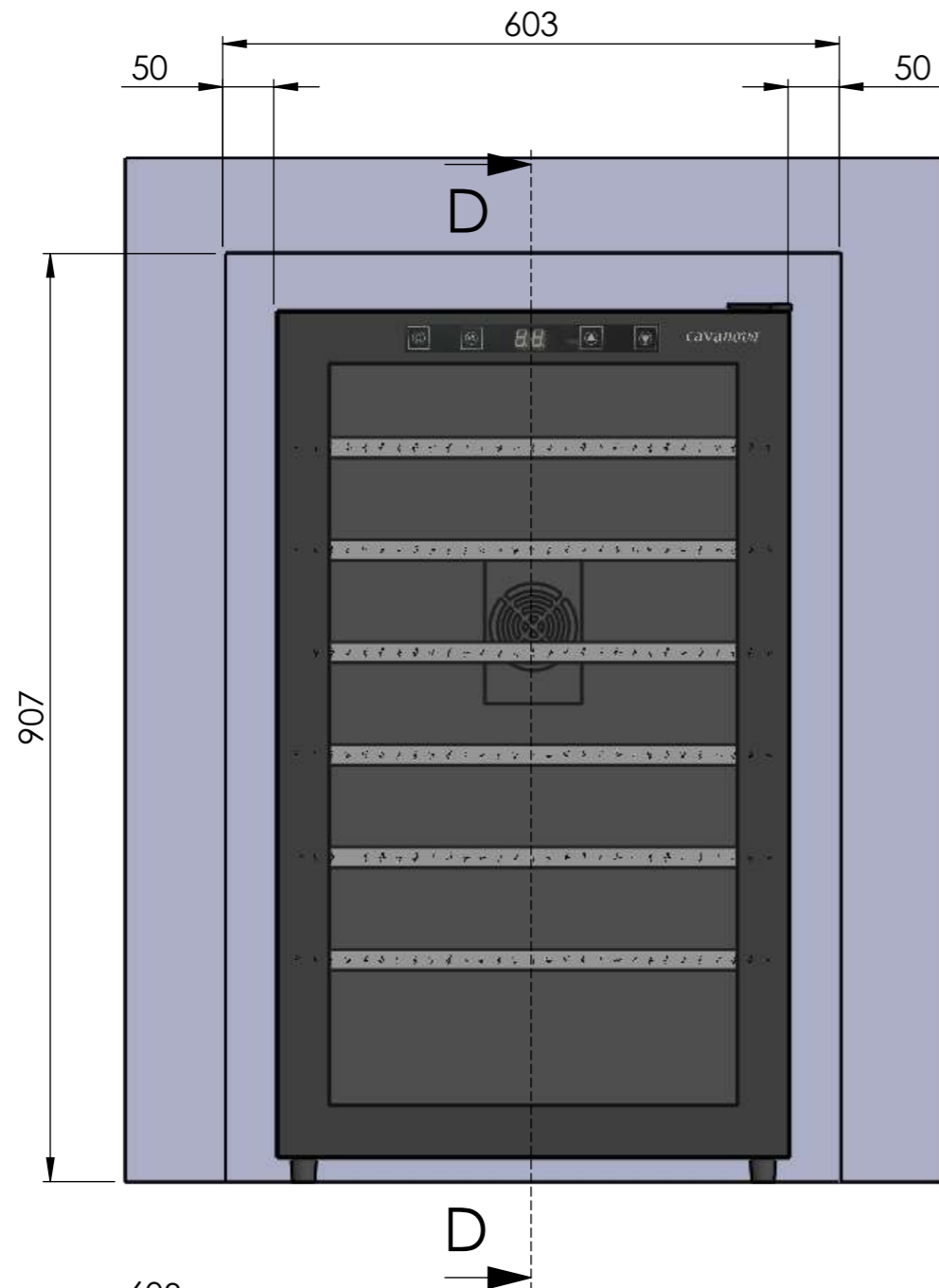

Ventilación adecuada para un correcto funcionamiento

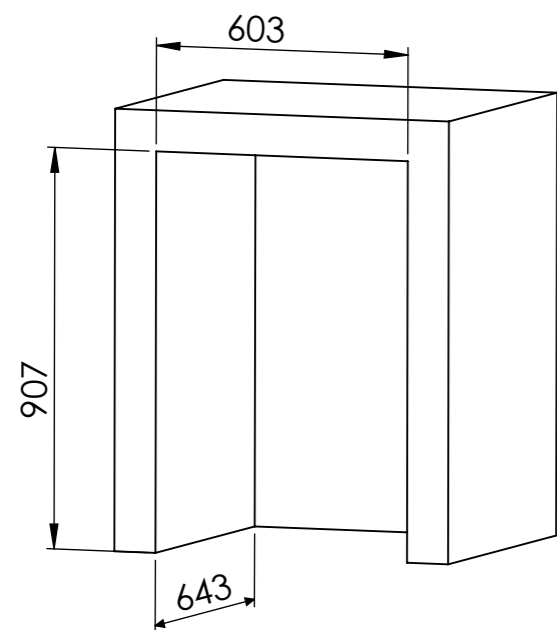

Medidas para hueco

Sign:

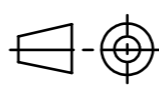
Date	Name	 <small>THE INFORMATION CONTAINED IN THIS DRAWING IS THE SOLE PROPERTY OF CAVANOVA WINE S.L. IN MÁLAGA, SPAIN. ANY REPRODUCTION IN PART OR AS A WHOLE WITHOUT THE WRITTEN PERMISSION OF CAVANOVA WINE S.L. IS PROHIBITED.</small>	
Design: 09/10/2018	Diego		
Checked:	Diego	Part name: CV048C-ENTORNO	Top assembly: CV048C
Modified:	Diego		
Scale: 1:10		Description: Empotramiento del equipo (built-in)	Client: Cavanova
Unit: mm			Material: Varios
			Reference: CV048C-ENTORNO
			Count:
			Pages: 4 OF 4