

CV022T

	Date	Name	 <p>THE INFORMATION CONTAINED IN THIS DRAWING IS THE SOLE PROPERTY OF CAVANOVA. ANY REPRODUCTION IN PART OR AS A WHOLE WITHOUT THE WRITTEN PERMISSION OF CAVANOVA IS PROHIBITED.</p>	
Design:	10/12/2018	Diego		
Checked:		Diego		
Modified:		Diego		
Notes:	Scale: 1:5	Part name: CV022T	Top assembly: CV022T	Client: Cavanaugh
		Description: Capacidad para 22 botellas		Material: Acero pintado
				Reference: CV022T
				Count: 1
				Pages: 1 OF 4

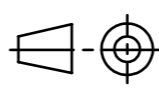

ALZADO

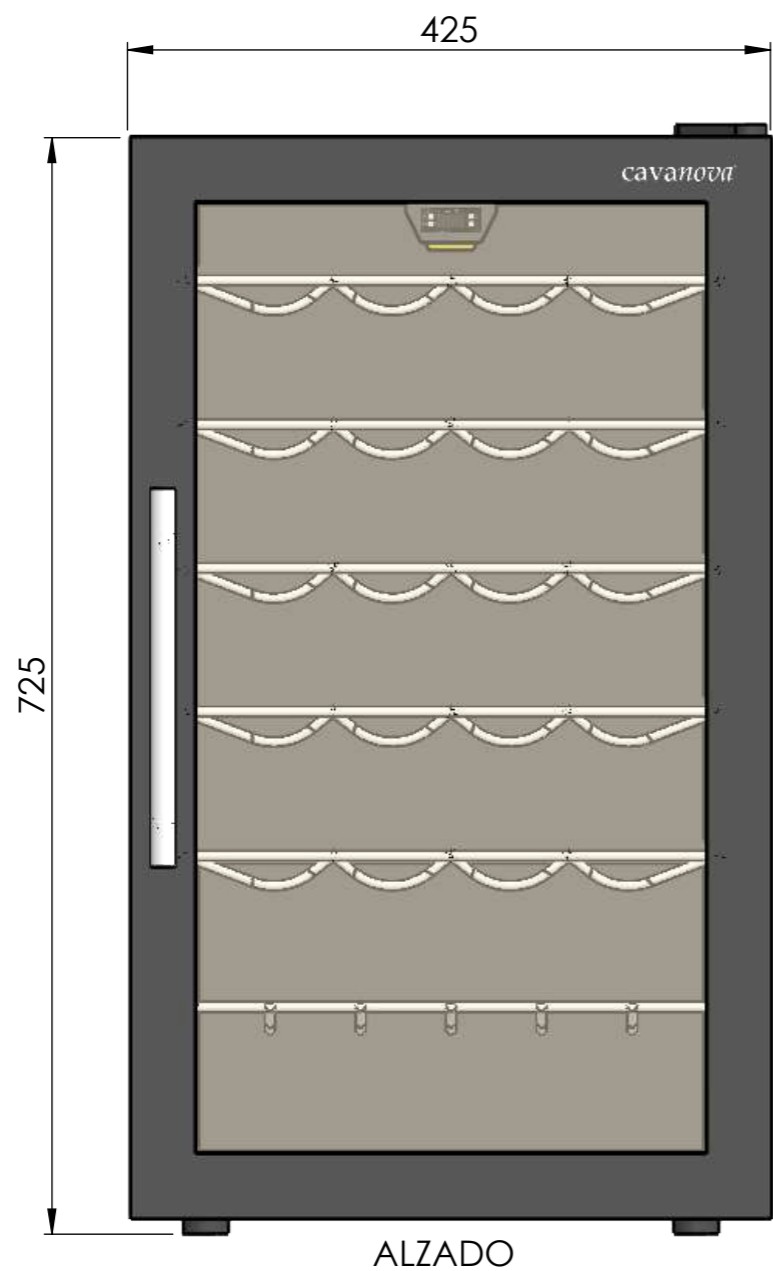
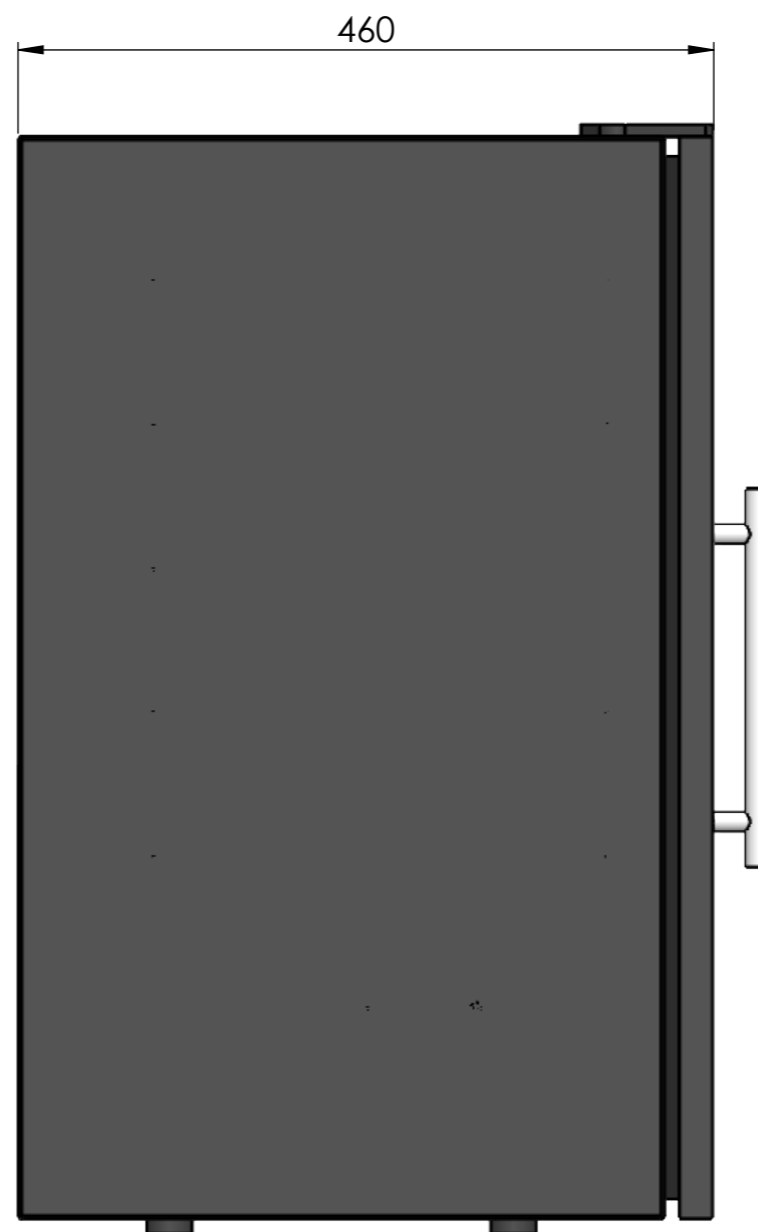

PERFIL

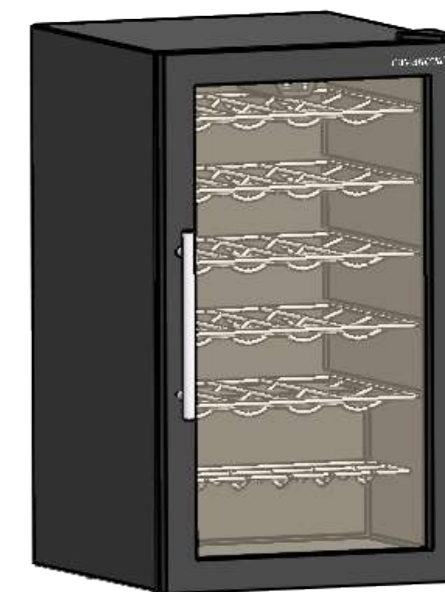

DATOS TÉCNICOS	
Volumen	62L
Peso	28kg
Botellas	2
Rango de temperatura	4-18°C
Frecuencia	50hz
Consumo	0.65(15°C)
Voltaje	220/240V
Ruido	43db
Refrigerante	R600a
Humedad interior	>70%RH
Refrigerante	R600a
Sistema de frío	Compresor

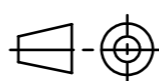
Date	Name	 <small>THE INFORMATION CONTAINED IN THIS DRAWING IS THE SOLE PROPERTY OF CAVANOVA WINE S.L. IN MÁLAGA, SPAIN. ANY REPRODUCTION IN PART OR AS A WHOLE WITHOUT THE WRITTEN PERMISSION OF CAVANOVA WINE S.L. IS PROHIBITED.</small>	
Design:	10/12/2018 Diego		
Checked:	Diego		
Modified:	Diego		
Scale: 1:20	Part name: CV022T	Top assembly: CV022T	Client: Cavanova
Unit: mm			Material: Acero pintado
	Description:	Reference: CV022T	
	Capacidad para 22 botellas	Count:	
		Pages: 2 OF 4	

Sign:

6 baldas de metal cromadas

Baldas extraíbles

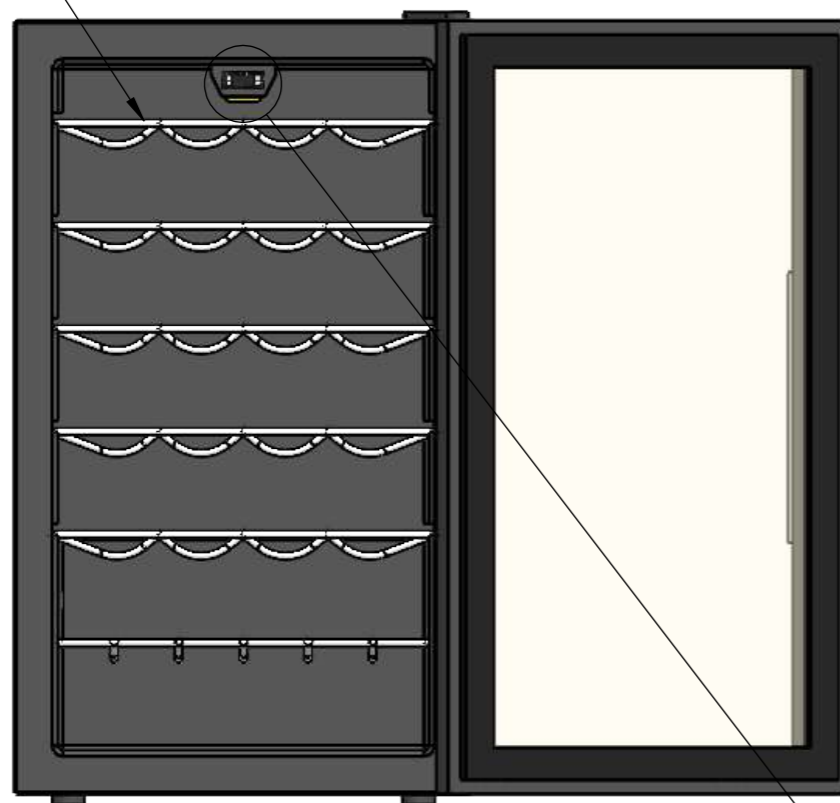

ALZADO

Compresor

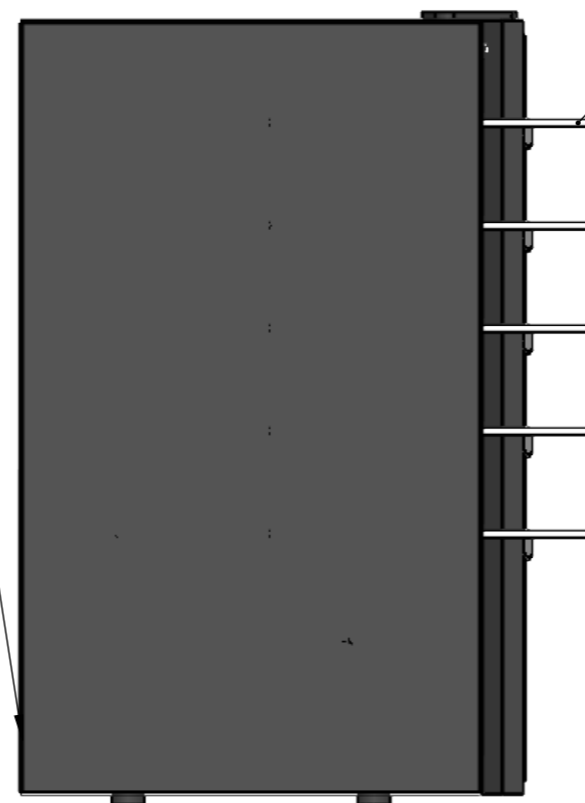

PERFIL

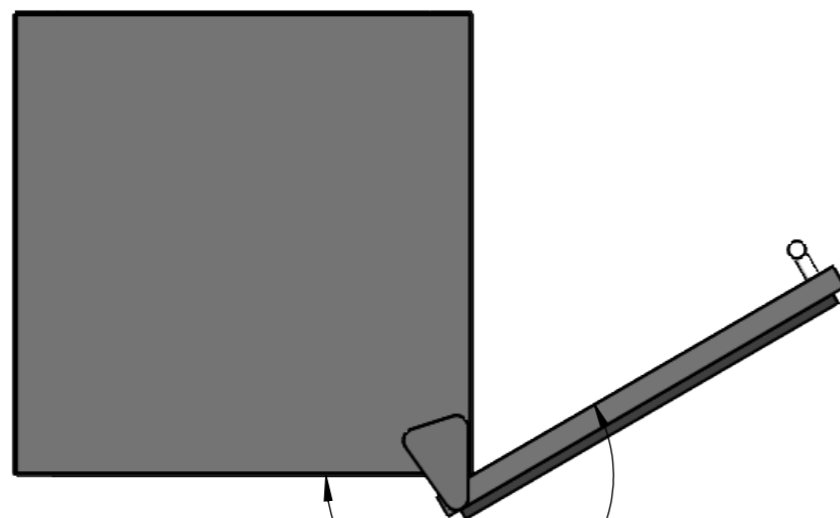
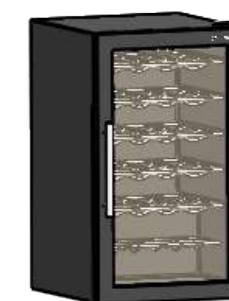

PLANTA

210° max. apertura

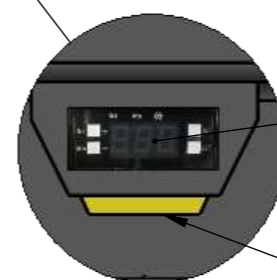

Control de temperatura

Luz

DATOS TÉCNICOS

Volumen	62L
Peso	28kg
Botellas	22
Rango de temperatura	4-18°C
Frecuencia	50hz
Consumo	0.65(15°C)
Voltaje	220/240V
Ruido	43db
Refrigerante	R600a
Humedad interior	>70%RH
Sistema de frío	Compresor

	Date	Name
Design:	10/12/2018	Diego
Checked:		Diego
Modified:		Diego
Scale: 1:20	Part name: CV022T	
Unit: mm	Top assembly: CV022T	

cavanova

THE INFORMATION CONTAINED IN THIS DRAWING IS THE SOLE PROPERTY OF CAVANOVA WINE S.L. IN MÁLAGA, SPAIN. ANY REPRODUCTION IN PART OR AS A WHOLE WITHOUT THE WRITTEN PERMISSION OF CAVANOVA WINE S.L. IS PROHIBITED.

Sign:

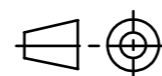

Description:
Capacidad para 22 botellas

Client:	Cavanova
Material:	Acero pintado
Reference:	CV022T
Count:	
Pages:	3 OF 4

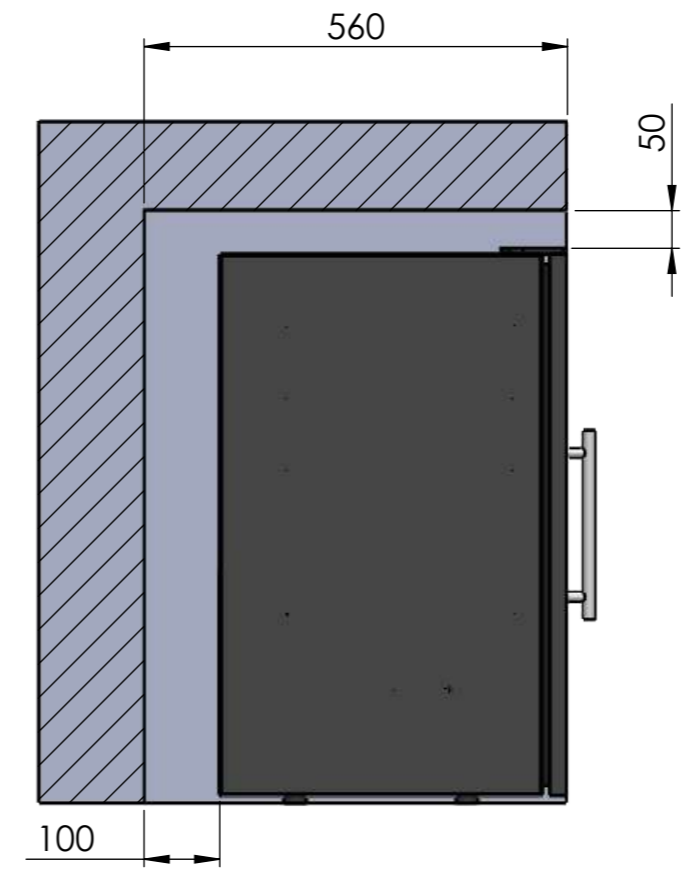
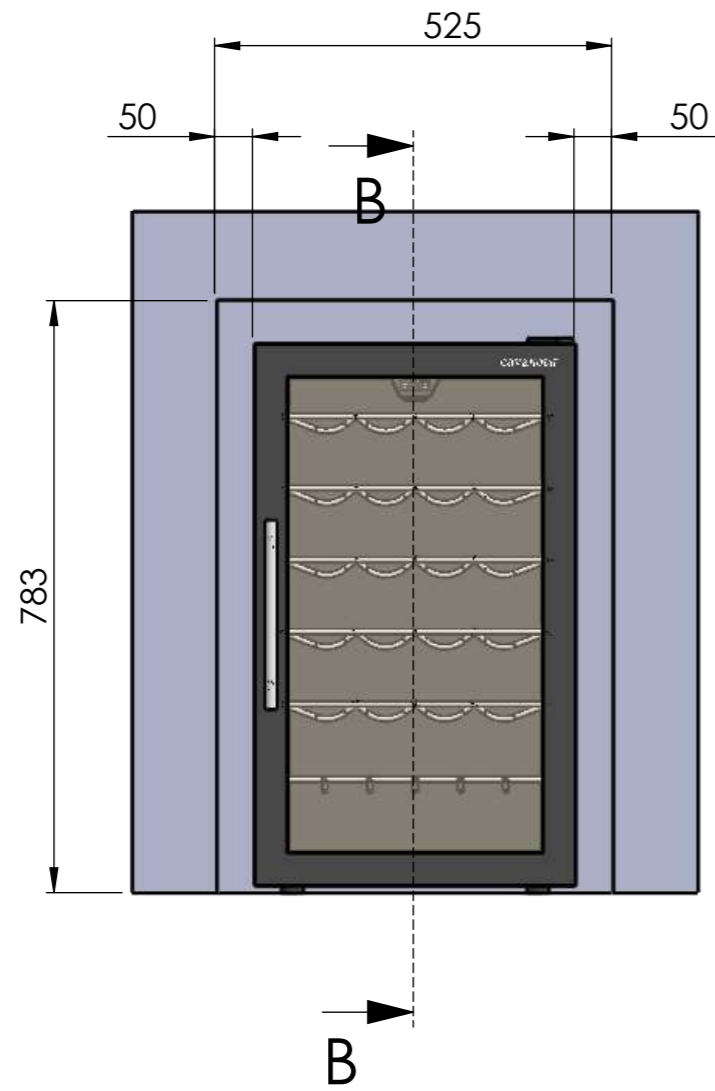

Medidas recomendadas	
Altura	783mm
Anchura	50mm por cada lado
Profundidad	100mm de espacio

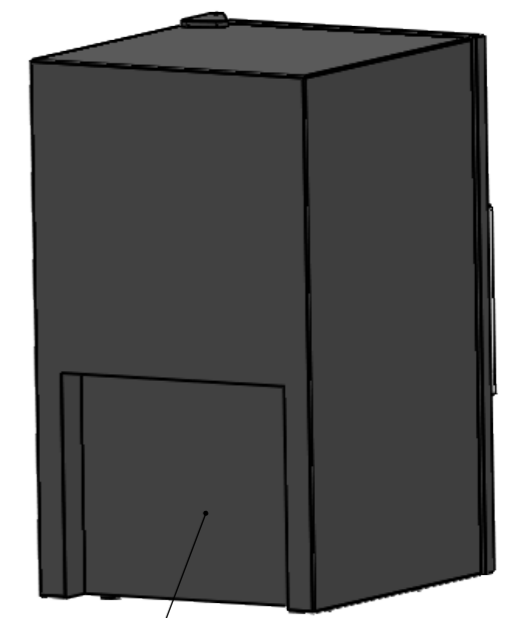
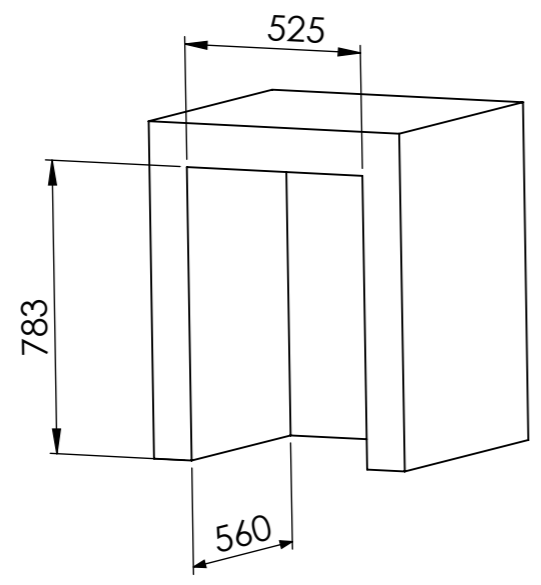

Compresor
(correcta ventilación)

Huevo para vinoteca

SECCIÓN B-B

Date	Name	 <small>THE INFORMATION CONTAINED IN THIS DRAWING IS THE SOLE PROPERTY OF CAVANOVA WINE S.L. IN MÁLAGA, SPAIN. ANY REPRODUCTION IN PART OR AS A WHOLE WITHOUT THE WRITTEN PERMISSION OF CAVANOVA WINE S.L. IS PROHIBITED.</small>		
Design: 09/10/2018	Diego			
Checked:	Diego	Part name: CV022T-ENTORNO	Top assembly: CV022T	Client: Cavanova
Modified:	Diego			Material: Varios
Scale: 1:20		Description: Ventilación del equipo	Reference: CV022T-ENTORNO	Count:
Unit: mm				Pages: 4 OF 4

Sign: