

CV090T

	Date	Name	 <small>THE INFORMATION CONTAINED IN THIS DRAWING IS THE SOLE PROPERTY OF CAVANOVA. ANY REPRODUCTION IN PART OR AS A WHOLE WITHOUT THE WRITTEN PERMISSION OF CAVANOVA IS PROHIBITED.</small>	
Design:	09/10/2018	Diego		
Checked:		Diego		
Modified:		Diego		
Notes:	Scale: 1:20	Part name: CV090T	Top assembly: CV090T	Client: Cavanova
		Description: Cava para vino tinto 82 botellas		Material: Acero inoxidable pintado
				Reference: CV090T
				Count: 1
				Pages: 1 OF 4

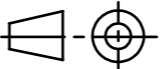
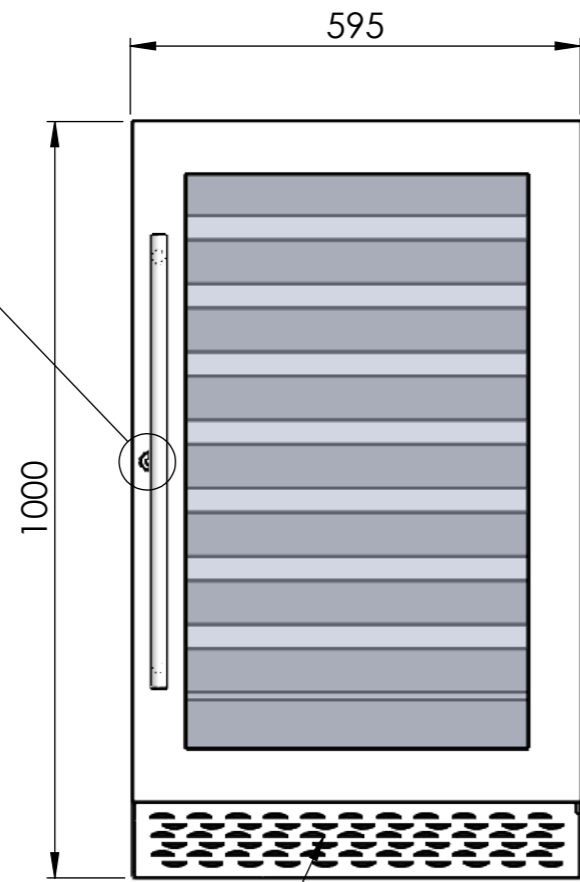
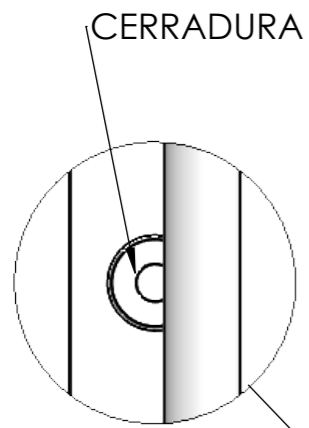

ALZADO

NO OBSTRUIR VENTILACIÓN

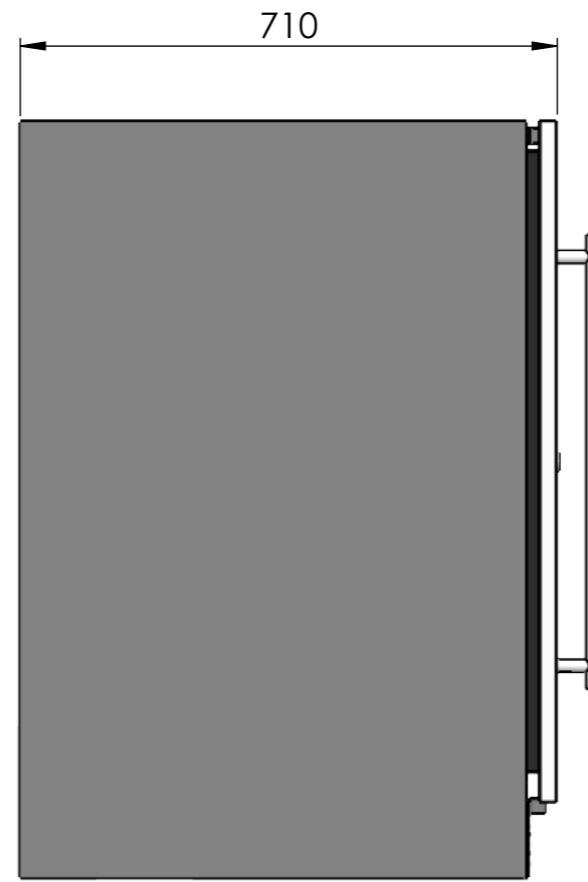

PERFIL

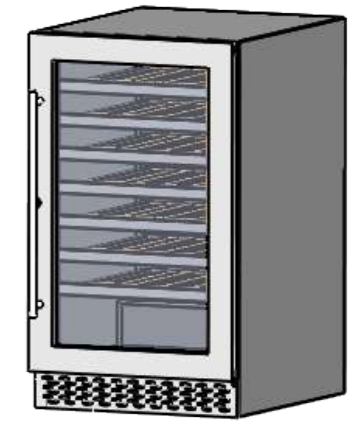

Volumen	204L
Frecuencia	50hz
Consumo	1(12°C)kw/d
Voltaje	220/240V
Ruido	42db
Refrigerante	R600a
Humedad interior	>70%RH
Sistema de frío	Compresor
Botellas	82
Rango de temperatura	5-20°C

	Date	Name
Design:	09/10/2018	Diego
Checked:		Diego
Modified:		Diego

cavanova

THE INFORMATION CONTAINED IN THIS DRAWING IS THE SOLE PROPERTY OF CAVANOVA WINE S.L. IN MÁLAGA, SPAIN. ANY REPRODUCTION IN PART OR AS A WHOLE WITHOUT THE WRITTEN PERMISSION OF CAVANOVA WINE S.L. IS PROHIBITED.

Sign:

Scale: 1:10	Part name: CV090T	Top assembly: CV090T
Unit: mm	Description: Cava para vino tinto 82 botellas	

Client:	Cavanova
Material:	Acero inoxidable pintado
Reference:	CV090T
Count:	
Pages:	2 OF 4

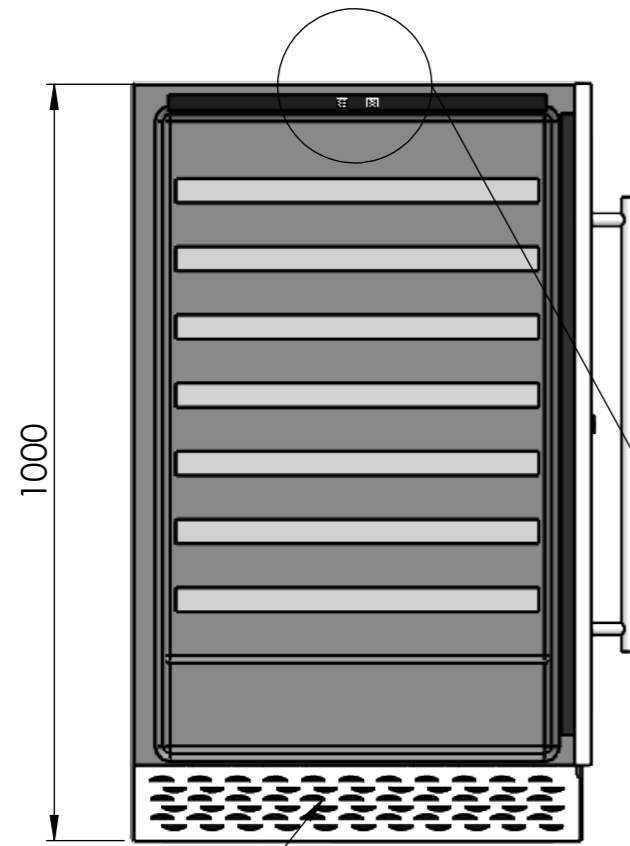

ALZADO

NO OBSTRUIR VENTILACIÓN

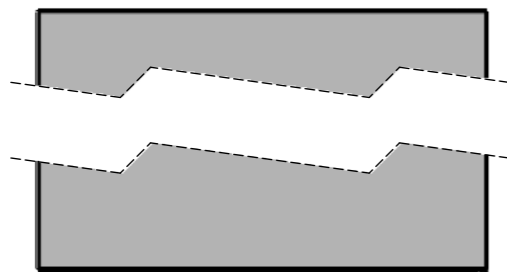

R595

PLANTA

110° max apertura

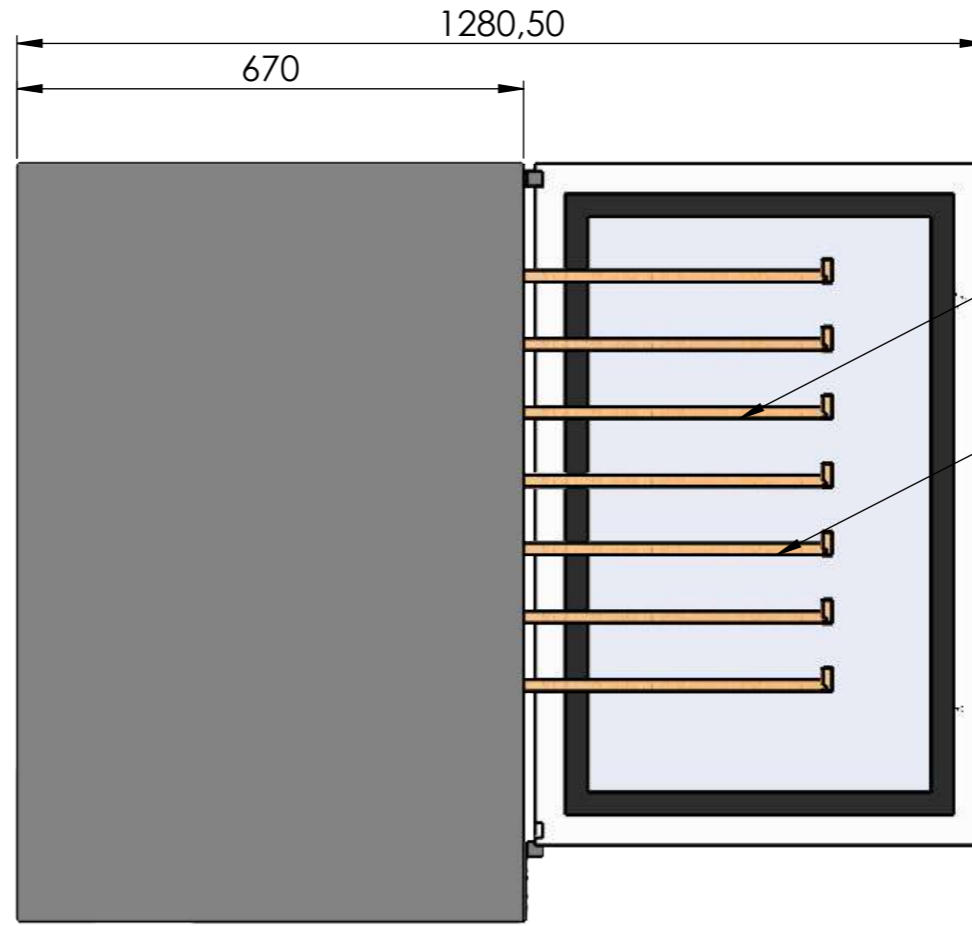

PERFIL

7 baldas de madera con acabado en inoxidable

Baldas extraíbles



Control de temperatura

Volumen	204L
Frecuencia	50hz
Consumo	1(12°C)kw/d
Voltaje	220/240V
Ruido	42db
Refrigerante	R600a
Humedad interior	>70%RH
Sistema de frío	Compresor
Botellas	82
Rango de temperatura	5-20°C

	Date	Name
Design:	09/10/2018	Diego
Checked:		Diego
Modified:		Diego

cavanoa

THE INFORMATION CONTAINED IN THIS DRAWING IS THE SOLE PROPERTY OF CAVANOVA WINE S.L. IN MÁLAGA, SPAIN. ANY REPRODUCTION IN PART OR AS A WHOLE WITHOUT THE WRITTEN PERMISSION OF CAVANOVA WINE S.L. IS PROHIBITED.

Sign:

Scale: 1:10
Unit: mm

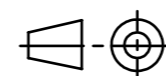

Part name: CV090T

Description:

Dimensiones con la puerta abierta

Top assembly: CV090T

Client: Cavanoa

Material: Varios

Reference: CV090T

Count:

Pages: 3 OF 4

MEDIDAS RECOMENDADAS	
ALTURA	1010mm
ANCHURA	605mm
PROFUNDIDAD	730mm

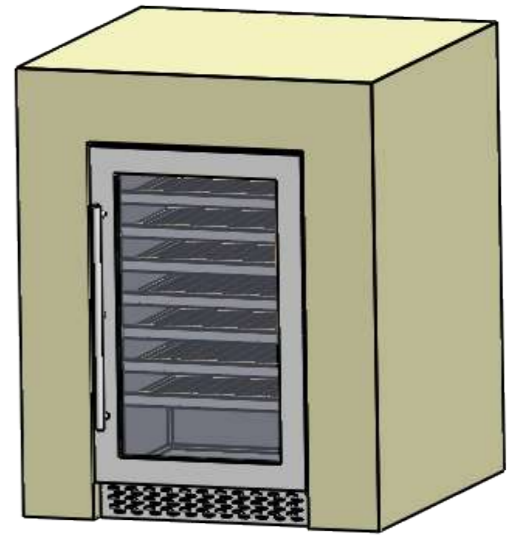
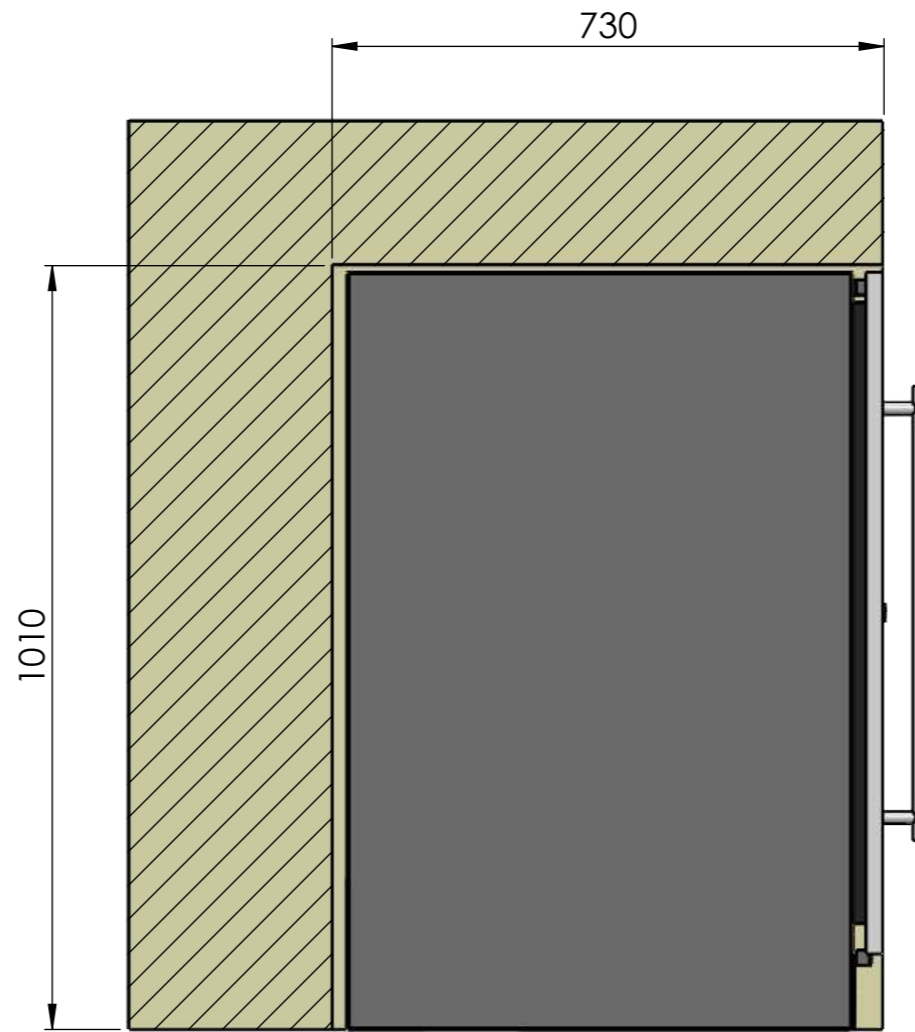
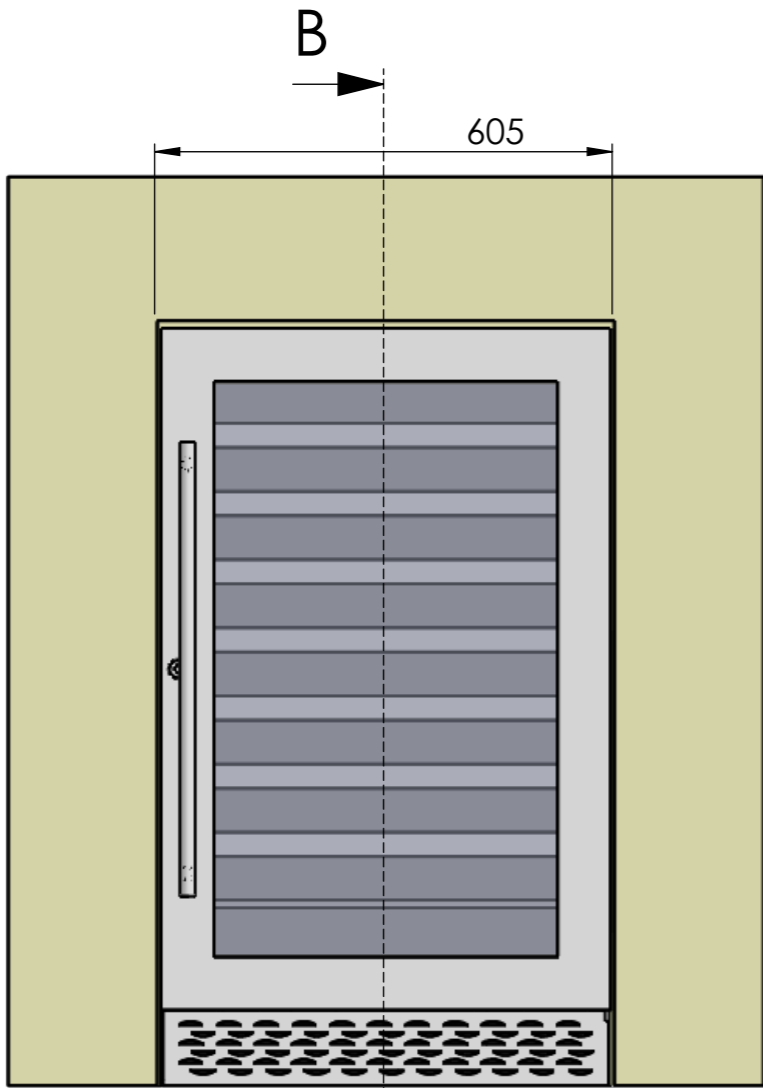

SECCIÓN B-B
ESCALA 1 : 10

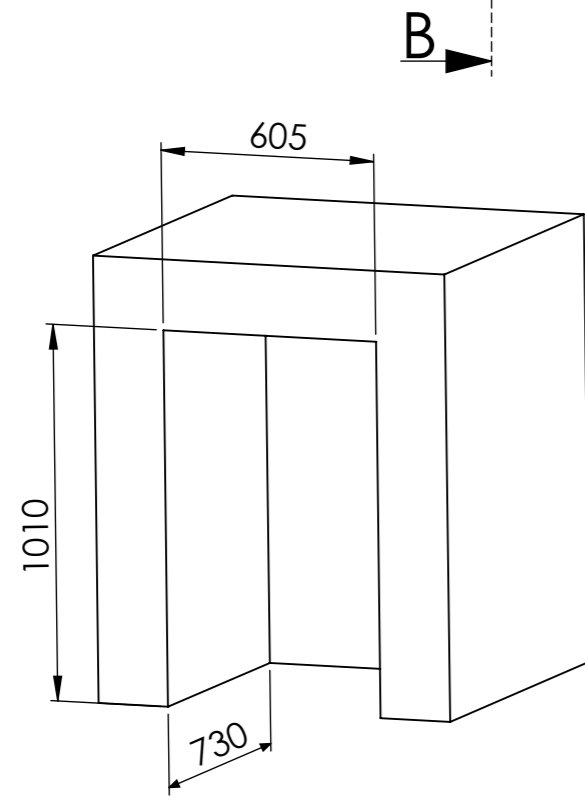

HUECO PARA INTEGRAR VINOTECA

Date	Name	cavanova®	
Design: 09/10/2018	Diego	THE INFORMATION CONTAINED IN THIS DRAWING IS THE SOLE PROPERTY OF CAVANOVA WINE S.L. IN MÁLAGA, SPAIN. ANY REPRODUCTION IN PART OR AS A WHOLE WITHOUT THE WRITTEN PERMISSION OF CAVANOVA WINE S.L. IS PROHIBITED.	
Checked:	Diego		
Modified:	Diego		
Scale: 1:20 Unit: mm	Part name: CV090T-ENTORNO	Top assembly: CV090T	Client: Cavanova
	Description: Empotramiento del equipo (built-in)		Material: Varios
			Reference: CV090T-ENTORNO
			Count:
			Pages: 4 OF 4

Sign: